



GT3800Ei / GT4800Ei

ELECTRIC START GENERATOR

3800W / 4600W



Please ensure that you read this manual in full before using your machine and follow the maintenance and operation instructions carefully.

OPERATING INSTRUCTIONS

Contents

Introduction.....	3
Environmental Protection.....	3
Scope of Product.....	3
Description of Symbols.....	3
Specifications.....	3
Safety Rules.....	4
Unpacking the Generator.....	6
Features and Controls.....	7
Control Functions.....	9
Preparation Before Operating.....	11
Calculating Your Power Needs.....	13
Operating the Generator.....	14
Maintenance.....	17
Transportation & Storage.....	20
Troubleshooting.....	22
Warranty.....	23

Introduction

Your new GT POWER Generator will more than satisfy your expectations. It has been manufactured under stringent quality standards to meet superior performance criteria. You will find your new tool easy and safe to operate, and, with proper care, it will give you many years of dependable service.



CAUTION: Carefully read through this entire Instruction Manual before using your new GT POWER Generator. Take special care to heed the Cautions and Warnings.

Your generator has many features that will make your job faster and easier. Safety, performance, and dependability have been given top priority in the development of this tool, making it easy to maintain and operate.

Environmental Protection

Recycle unwanted materials instead of disposing of them as waste. All tools, hoses and packaging should be sorted, taken to the local recycling centre and disposed of in an environmentally safe way.



Scope Of Product

This product is suited for home and camping, back-up power, rural and commercial applications.

Description Of Symbols

The rating plate on your tool may show symbols. These represent important information about the product or instructions on its use.



Wear hearing protection.
Wear eye protection.
Wear breathing protection.



Conforms to relevant standards for electromagnetic compatibility.

Specifications

	GT3800Ei	GT4800Ei
Rated AC Output:	3500W	4200W
Max. AC Output:	3800W	4600W
Rated Voltage	230V	
Frequency:	50Hz	
Phase:	Single	
Power Factor:	1	
Engine:	PD225PRO	PD272PRO
	4 Stroke OHV	4 Stroke OHV
Starting:	Manual Recoil & Electric	
Fuel:	Unleaded petrol	
Fuel Tank Capacity:	10L	
Oil :	SAE10W40	
Oil Capacity:	0.6L	1.0L
Displacement:	224cc	272cc
Noise Level	65 dBA	
Run Time:	11.1hr@25% 7.14hrs@50% 5.57hrs@75%	10.75hr@25% 6.41hrs@50% 2.04hrs@75%
AC Power Sockets:	2 x 15A (230V)	
	1 x 8.3A (12V)	
Dimensions:	530x350x490mm	
Weight:	34kg	39.5kg

Safety Rules

Read this manual carefully and become familiar with your generator. Know its applications, its limitations and any hazards involved.

Throughout this brochure, on tags and decals affixed to the generator, **DANGER**, **WARNING**, **CAUTION** and **NOTICE** marks are used to alert personnel with special instructions about a particular operation that may be hazardous if performed incorrectly, or carelessly. Observe them carefully. Their definitions are as follows:



DANGER! indicates a hazard which, if not avoided, will result in death or serious injury.



WARNING! indicates a hazard which, if not avoided, could result in death or serious injury.



CAUTION! indicates a hazard which, if not avoided, could result in minor or moderate injury.



NOTE: covers some practices which may be not related to personal injury.

A running engine gives off carbon monoxide, an odourless, colourless, poison gas. Breathing carbon monoxide could result in death, serious injury, headache, fatigue, dizziness, vomiting, confusion, seizures, nausea or fainting.

- Operate this product **ONLY** outdoors.
- Install a battery operated carbon monoxide alarm near the bedrooms.
- Keep exhaust gas away from entering a confined area through windows, doors, ventilation intakes, or other openings.

- NEVER operate this product inside any building, carport, porch, mobile equipment, marine applications, or enclosure, even if windows and doors are open.



WARNING! *Starter cord kickback (rapid retraction) will pull hand and arm toward engine faster than you can let go which could cause broken bones, fractures, bruises, or sprains resulting in serious injury.*

- When starting engine, pull cord slowly until resistance is felt and then pull rapidly to avoid kickback.
- NEVER start or stop engine with electrical devices plugged in and turned on.



WARNING! *Fuel and its vapours are extremely flammable and explosive which could cause burns, fire or explosion resulting in death, serious injury and/or property damage.*

When Adding or Draining Fuel

- Turn generator engine OFF and let it cool at least 2 minutes before removing fuel cap. Loosen cap slowly to relieve pressure in tank.
- Fill or drain fuel tank outdoors.
- DO NOT overfill tank, Allow space for fuel expansion.
- If fuel spills, wait until it evaporates before starting engine.
- Keep fuel away from sparks, open flames, pilot light, heat, and other ignition sources.
- Check fuel lines, tank, cap and fittings frequently for cracks or leaks. Replace if necessary.
- DO NOT light a cigarette or smoke.

When Starting Equipment

- Ensure spark plug, muffler, fuel cap and air cleaner are in place.
- DO NOT crank engine with spark plug removed.

When Operating Equipment

- DO NOT operate this product inside any building, carport, porch, mobile equipment, marine applications or enclosure.
- DO NOT tip engine or equipment at angle which causes fuel to spill.
- DO NOT stop engine by moving choke control to "OFF" position.

When Transporting or Repairing Equipment

- Transport/move/repair with fuel tank EMPTY or with fuel valve OFF.
- DO NOT tip engine or equipment at angle which cause fuel to spill.
- Disconnect spark plug wire.

When Storing Fuel or Equipment with Fuel in Tank

- Store away from furnaces, stoves, water heaters, clothes dryers, or other appliances that have light or other ignition source because they could ignite fuel vapors.

 **WARNING!** *Generator voltage could cause electrical shock or burn resulting in death or serious injury.*

- Use approved transfer equipment to prevent back feed by isolating generator from electric utility workers.
- When using generator for backup power, notify utility company.

- Use a ground fault circuit interrupter in any damp or highly conductive area, such as metal decking or steel work.
- DO NOT touch bare wires or receptacles.
- DO NOT use generator with electrical cords which are worn, frayed, bare or otherwise damaged.
- DO NOT operate generator in the rain or wet weather.
- DO NOT handle generator or electrical cords while standing in water, while bare-foot, or while hands or feet are wet.
- DO NOT allow unqualified persons or children to operate or service generator.

 **WARNING!** *Exhaust heat/gases could ignite combustibles, structures or damage fuel tank causing a fire, resulting in death, serious injury and/or property damage. Contact with muffler area could cause burns resulting in serious injury.*

- DO NOT touch hot parts and AVOID hot exhaust gases.
- Allow equipment to cool before touching.
- Keep at least 5 feet (1.5m) of clearance on all sides of generator including overhead.

 **CAUTION!** *Excessively high operating speeds could result in minor injury and/or generator damage. Excessively low speeds impose a heavy load.*

- DO NOT tamper with governor spring, links or other parts to increase engine speeds. Generator supplies correct rated frequency and voltage when running at governed speed.

 **WARNING!** *Unintentional sparking could cause fire or electric shock resulting in death or serious injury.*

When Adjusting or Making Repairs to the Generator

- Disconnect the spark plug wire from the spark plug and place the wire where it cannot contact spark plug.

When Testing for Engine Spark

- Use approved spark plug tester.
- DO NOT check for spark with spark removed.



WARNING! *Starter and other rotating parts could entangle hands, hair, clothing, or accessories resulting in serious injury.*

- NEVER operate generator without protective housing or covers.
- DO NOT wear loose clothing, jewellery or anything that could be caught in the starter or other rotating parts.
- Tie up long hair and remove jewellery.
- DO NOT modify generator in any way.



NOTE: *Exceeding generators wattage/ampere capacity could damage generator and/or electrical devices connected to it.*

- DO NOT exceed the generator's wattage/ampere capacity. See Don't Overload Generator in the Operation section.
- Start generator and let engine stabilize before connecting electrical loads.
- Turn electrical loads OFF and disconnect from generator before stopping generator.



NOTE: *Improper treatment of generator could damage it and shorten its life.*

- Use generator only for intended uses.
- If you have questions about intended use, ask dealer or contact local service centre.

- Operate generator only on level surfaces.
- DO NOT expose generator to excessive moisture, dust, dirt, or corrosive vapor.
- DO NOT insert any object through cooling slots.
- If connected devices overheat turn them off and disconnect them from generator.
 - or electrical output is lost.
 - or equipment sparks, smokes, or emits flames.
 - or unit vibrates excessively turn them off and disconnect them from generator.

Unpacking the Generator

- Set the carton on a rigid flat surface.
- Remove everything from carton except generator.
- Open carton completely by cutting each corner from top to bottom.
- Leave generator on carton to install wheel kit.

Packing Contents

- 1 x Owner's Manual
- 1 x Generator Set
- 1 x 0.6L Engine Oil (GT4800Ei = 2 x 0.6L)
- 1 x Hardware Bag (includes 1 x Spark Plug Socket, 1 x Extension Tool, 1 x Funnel)

Features and Controls

Read this Operating Manual and the Safety Rules section before operating your generator. Compare the illustrations with your generator, to familiarise yourself with the locations of various controls and adjustments. Save this manual for future reference.



1. Fuel Cap
2. Fuel Level Indicator
3. Fuel Tank
4. Carry Handle
5. Control Panel
6. Recoil Start
7. Air Filter
8. Fuel Valve
9. Oil Drain Plug
10. Oil Fill Cap/Dipstick



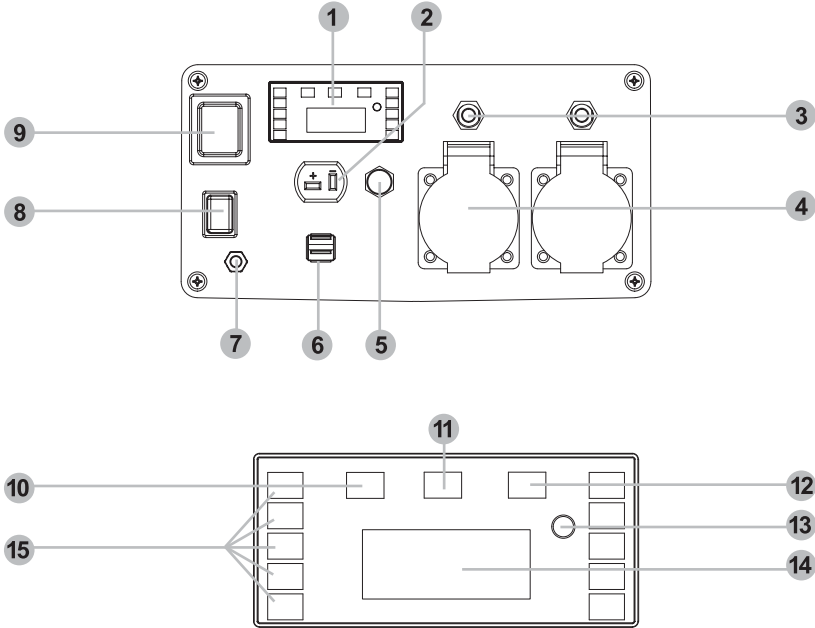

- | | |
|------------------------|------------------------------|
| 1. Display | 10. Overload Alarm |
| 2. 12V Socket | 11. Output Indicator |
| 3. 230V AC Breakers | 12. Low Oil Alarm |
| 4. 230V AC Sockets | 13. Parameter Reset Button |
| 5. 12V AC Breaker | 14. Parameter Display |
| 6. 2 x USB Ports | 15. Generator Load Indicator |
| 7. Ground Terminal | 16. 2 x USB Outlets |
| 8. Eco Mode Switch | |
| 9. Start / Stop Switch | |

Control Functions

LED Indicators

The LED Indicators assist in communicating proper and improper functions of the unit.

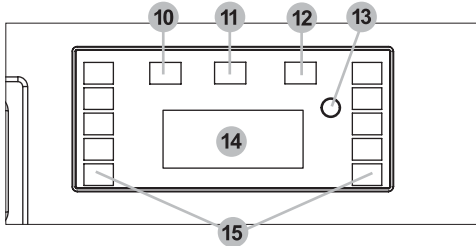

Output Indicator (11)

The AC Output Indicator (pilot light) comes on when the engine starts and produces power.

Overload Alarm (10)

The Overload Alarm comes on when a connected device requires more power than the generator is able to produce, the inverter control unit overheats, or the AC output voltage rises above rated values. The Output Indicator (Green) will go off and the Overload Alarm (Red) will stay on, but the engine will continue to run.

When the Overload Alarm light comes on and power generation stops, proceed as follows:

1. Turn off any connected electric devices and stop the engine.
2. Reduce the total wattage of connected electric devices within the rated output.
3. Check for blockages in the cooling air inlet and around the control unit. If any blockages are found remove them.
4. After checking, restart the engine.

NOTE: The Overload Alarm may come on for a few seconds when first using

electrical devices that require a large starting current, such as a compressor, pump, or refrigerator. This is normal behaviour it is not a malfunction.

Low Oil Alarm (12)

When the engine oil falls below the required level the Low Oil Alarm will come on and the engine will stop automatically. The engine will not restart until oil is added to the unit to bring it up to the appropriate level.



CAUTION!

Generator should only be operated on a level surface. DO NOT operate the generator on loose ground or obvious inclines. The low oil shutdown feature may be prematurely activated in these cases causing the engine to not start.

Side Pilot Columns (15)

The side pilot columns are general load indicators, showing an approximate load used by the generator with respect to the total rated power.

Parameter Display (14)

The control panel is equipped with a parameter display meter that shows voltage, frequency and hour run time. Press the mode change button (13) on the meter to cycle through each value.

The meter functions are as follows:

- Output voltage in volts (V)
- Output current in amps (A)
- Output power in watts (P)
- Output frequency in hertz (Hz)
- Total operating hours (H)

AC (3) and DC (5) Reset Circuit Breakers)

The Circuit Breakers turn the generator “OFF” automatically when an electrical device connected to the generator is operating above the rated current. To use this equipment again, turn on the Circuit Breaker by pressing in its button to “ON”. If Circuit Breaker cuts power out again, reduce the load of the connected electric device below the specified rated output of the generator and press button in to “ON” again.

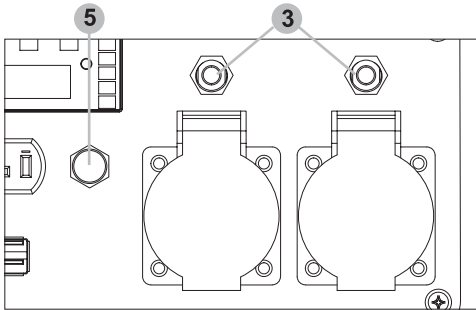

⚠ NOTE: *If the Circuit Breaker continues to cut out, stop using the device immediately and consult your local authorised Powertec Service Provider.*

⚠ NOTE: *Remember that many types of equipment need extra consumption for start up. Equipment that uses an engine such as compressors, water pumps, circular saws etc. can consume up to 3 times more power for start up. For example a 1000W water pump will need 3000W to start up, therefore a generator 3000W or more would be required.*

ECO Mode Switch (8)

When the ECO switch is in the “ON” position the smart throttle controls the engine speed

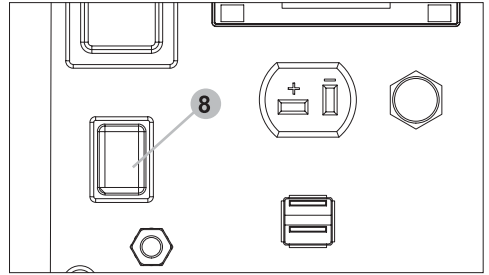

according to the connected electrical load. The results are better fuel consumption and less noise.

When the switch is in the “OFF” position the engine runs at 3600rpm regardless of whether there is a load connected or not.

⚠ NOTE: *The ECO switch must be turned to “OFF” when using electrical devices that require a large starting current, such as a compressor or a submersible pump.*

Generator Ground / Earth Circuit (7)

The Earth terminal is used to earth the generator when earthed electrical devices are being used. Consult an electrician for local earthing regulations.

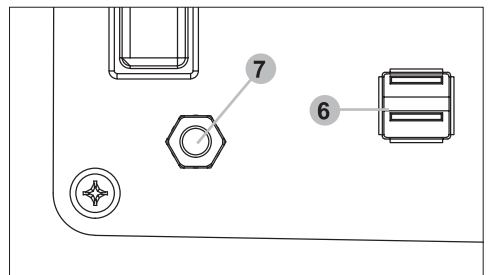

USB Outlet (6)

The USB outlet is used to power and charge anything with a USB plug, such as phones, media players and other 5V DC devices.

Preparation before Operating

Battery Connection

The battery supplied has the negative terminal disconnected. Before connecting check that the engine switch is in the 'OFF' position. Connect the negative wire.

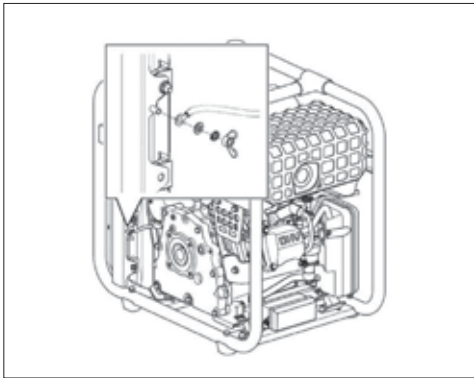

⚠ NOTE: *The battery supplied is NOT covered under warranty. Batteries have limited lifespans and should be replaced when required by a battery with the same specifications.*

Adding Engine Oil

Please add correct oil before starting the generator.

Above 5°C - use **SAE 30**

Between 5°C to -15°C - use **10W-30**

Oil Capacity - GT3800Ei - 600ml

- GT4500Ei - 1L

⚠ NOTE: *Improper treatment of generator could damage it and shorten its life. DO NOT attempt crank or start the engine before it has been properly serviced with the*

recommended oil. This could result in an engine failure.

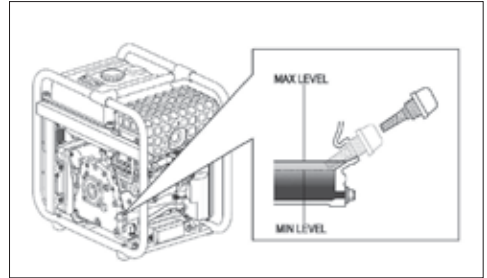

- Place generator on a flat, level surface.
- Remove oil cap and dipstick. Wipe dipstick clean.
- Slowly fill oil into engine through the oil filter until it reaches the full mark on the dipstick.
- Stop filling occasionally to check oil level. Be careful to not overfill.
- Install oil fill cap and fasten the cap properly.
- Check engine oil level before starting each time thereafter.

⚠ NOTE: *Never use old, dirty or bad oils. Do not use oil if you don't know it's grade or quality. Do not mix different types of oils.*

Adding Fuel

⚠ DANGER! *Never fill tank indoors. Never fill fuel tank when engine is running or hot. Turn generator engine OFF and allow engine to cool entirely before filling fuel tank. Avoid spilling gasoline on HOT engine. Keep fuel away from sparks, open flames, pilot lights, heat, and other ignition sources. DO NOT light a cigarette or smoke when filling the fuel tank. Fuel is highly FLAMMABLE and its vapours are EXPLOSIVE.*

- Use only regular UNLEADED gasoline. Do not use any fuel blends with ethanol or methanol.
- Do not mix oil with fuel.
- Avoid dirt and water entering the fuel tank.
- Install fuel cap and wipe up any spilled gasoline.



CAUTION! Do not overfill the fuel tank. Allow space for fuel expansion.

If the fuel tank is overfilled, fuel can overflow onto a HOT engine and cause FIRE or EXPLOSION. If fuel spills, wait until it evaporates before starting engine.

Check fuel lines, tank, cap and fittings frequently for cracks or leaks. Replace if necessary.

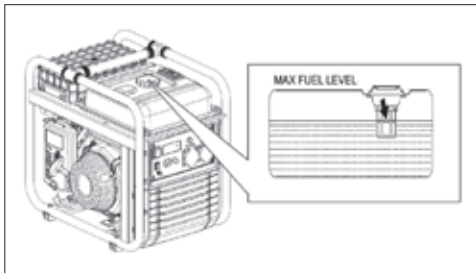

NOTE: It is important to prevent gum deposits from forming in fuel system parts such as the carburetor, fuel hose or tank during storage. Alcohol-blended fuels (called gasohol), ethanol or methanol can attract moisture, which leads to separation and formation of acids during storage. Acidic gas can damage the fuel system should be emptied before storage for 30 days or longer. See the "Storage" section. Never use engine or carburetor cleaner products in the fuel tank as permanent damage may occur.

- Remove the fuel cap, turning counter clockwise.
- Fill the tank with regular unleaded gasoline without exceeding the maximum level.
- Approximate capacity of fuel tank is 10L. Fuel gauge indicates fuel level.

Earthing the Generator

Proper earthing (grounding) of the generator will help prevent electrical shock in the event of earth fault condition in the generator or in connected electrical devices. Proper earthing also helps dissipate static electricity, which often builds up in un-earthed devices. Contact an electrician for local earthing regulations.

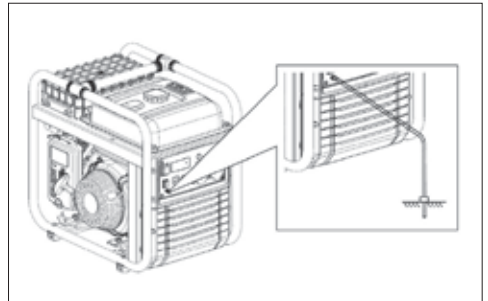

Calculating Your Power Needs

1. Firstly list all items requiring power simultaneously.
2. Then add up all the “running wattage” requirements for all items.
3. Add to that total the highest of the “starting wattages” you listed down. Now you know approximately how much power you need to start and run your appliances and equipment.

This chart below lists average power requirements. Your particular tool or appliance may require more or less than the listed wattage. Where START wattage is the same as RUN wattage, this signifies no additional power is required for starting.

Tool or Appliance	Running Watts	Starting Watts
1.		
2.		
3.		
4.		
5.		
Total Running Watts		
Highest Starting Watts		

= Generator Power Needs

--

Appliances	Approx Run (W)	Approx Start (W)	Appliances	Approx Run (W)	Approx Start (W)
Microwave 750W	750	1200	Central Air Conditioner:		
Coffee Maker	1750	1750	10,000 BTU	1500	2200
Electric Clothes Drier	5750	5750	24,000 BTU	3800	5000
Washing Machine	1150	2300	32,000 BTU	5000	6500
Refrigerator	700	2200	Room Air Conditioner		
Lights	100	100	10,000 BTU	1500	2200
Colour Television	350	350	Circular Saw 7 1/4"	1400	2300
Electric Frypan	1500	1500	Chainsaw 2HP	1100	2500
Dehumidifier	400	400	Portable Air Compressor	1200	3600
Computer - Desktop	700	700	Hand Drill 1/2"	600	900
VCR	50	50	Drill 1/2"	600	900
Dishwasher - Cool Dry	700	1400	Battery Charger - 15 amp	500	700
- Hot Dry	1450	2000	Electric Welder - 200 amp AC	9000	9000
Toaster - 2 Slice	1250	1250	Jigsaw	300	400
- 4 Slice	1600	1600	Electric Weed Trimmer	500	650
Freezer	2200	2500	Router	1000	1300
Hair Dryer	800-1700	800-1700	Belt Sander	1000	1300
Steam Iron	1800	1800	Table Saw 10"	1750	4250
Garage Door Opener - 1/4 HP	550	1100	Bench Grinder	1400	2450
- 1/3 HP	725	1400	Concrete Mixer 3.5c/f	1900	2500
Radio	200	200	Band Saw	1100	1350
Blender	375	500	Power Drill - Medium	1000	1200
Sump Pump 1/2 HP	1050	2150	- Heavy Duty	1500	1800
Well Pump 1/2 HP	1000	2100	Angle Grinder - 100mm	1000	1200
Household Water Pump	1200	2700	- 230mm	2400	2700

Operating the Generator

Starting the Engine

WARNING! Never start or stop engine with electrical devices plugged into the receptacles and devices turned on.

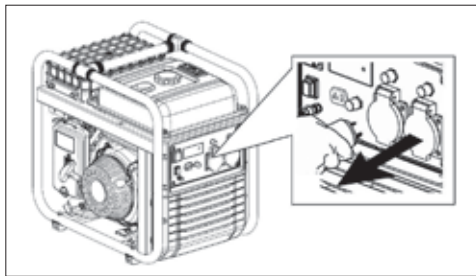

Unplug all electrical loads from the unit's receptacles before starting the engine. Make sure the unit is in a level position.

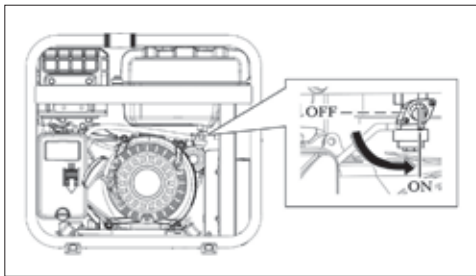

- Turn fuel valve to "ON" position.

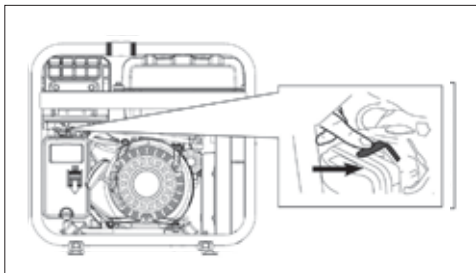

- Turn choke to "ON" position.

NOTE: It may not be necessary to use the choke if the engine has been shut down and is warm.

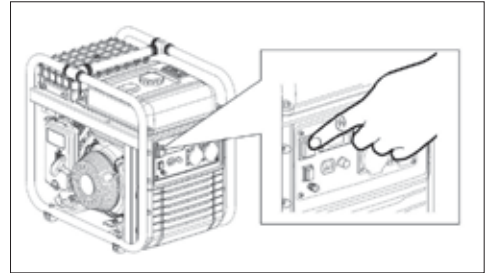

- Turn key ignition switch to "ON" and then to "START". release once engine has started

NOTE: If engine does not start up within 3 to 4 seconds, release key ignition and wait for a few seconds before trying again to avoid overheating the starting motor.

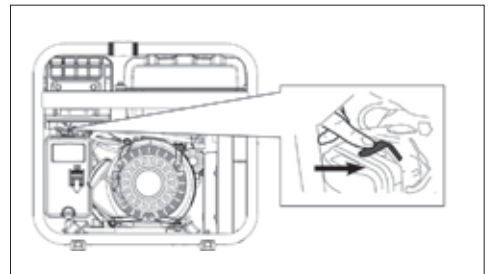

- Once started, move the choke lever slowly completely over to the "ON" position.

During the first startup of the machine, the battery's charge may be low if stored for too long. If the charge is not sufficient, start the generator manually with the recoil start

Recoil Start

- For recoil start, firmly grasp the recoil handle and pull slowly until increased resistance is felt. Pull rapidly up and away.

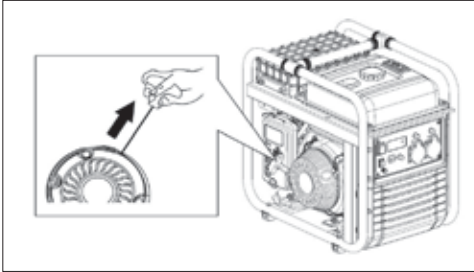

- When engine starts, move choke lever to 1/2 "CHOKE" position till engine runs smoothly and then fully into "RUN" position. If engine falters, choke back to 1/2 "CHOKE" position till engine running smoothly and then fully into "RUN" position again. If battery is unavailable, use manual starting instructions.
- If engine is choking and running move choke lever to the "CHOKE" position and repeat starting instructions.

⚠ WARNING! *Starter cord kickback (rapid retraction) will pull hand and arm toward engine faster than you can let go which could cause broken bones, fractures, bruises, or sprains resulting in serious injury. When starting engine, pull cord slowly until resistance is felt and then pull rapidly to avoid kickback. Never start or stop engine with electrical devices plugged in and turned on.*

- If engine fails to start after 3 pulls, or if unit shut down during operation, make sure unit is on a level surface and check for proper oil level in crankcase. This unit is equipped with a low oil protection

device. Oil must be checked and at proper level for engine to start and run.

⚠ WARNING! *Exhaust heat/ gases could ignite combustible, structures or damage fuel tank causing a fire, resulting in death, serious injury and/or property damage. Contact with muffler area could cause burn resulting in serious injury. DO NOT touch hot parts and AVOID hot exhaust gases. Allow equipment to cool before touching.*

- Keep at least 150cm of clearance on all sides of generator including overhead.
- Replacement parts must be the same and installed in the same position as the original parts

⚠ NOTE: *Do not overload the generator. Also, do not overload individual panel receptacles. These outlets are protected against overload with push-to-reset-type circuit breakers. If amperage rating of any circuit breaker is exceeded, that breaker opens and electrical output to that receptacle is lost.*

Connecting Electrical Loads

- Add up the total wattage of all electrical devices to be connected at one time. This total should NOT be greater than the generator's wattage capacity.

⚠ NOTE: *The rated wattage of lights can be taken from light bulbs. The rated wattage of tools, appliances and motors can usually be found on a data label or decal affixed to the devices.*

If the appliance, tool or motor does not give wattage, multiply volts times ampere rating to determine watts

(volts × amps = watts). Some electric motors, such as induction types, require about three times more watts of power for starting than for running. This surge of power lasts only a few seconds when starting such motors. Make sure to allow for high starting wattage when selecting electrical devices to connect to the generator:

- Figure the watts needed to start the largest motor.
- Add to that figure the running watts of all other connected loads. The wattage reference guide on page 13 is provided to assist in determining how many items the generator can operate at one time.



NOTE: Start generator and let engine stabilise before connecting electrical loads. Connect electrical loads in OFF position then turn ON for operation. Turn electrical loads OFF and disconnect from generator before stopping generator.

- Let engine run till stable and warm up for a few minutes after starting.
- Plug in and turn on the electrical loads.



NOTE: Overloading a generator in excess of its rated wattage capacity can result in damage to the generator and to connected electrical devices.

Stopping The Engine

To stop the engine in an emergency, turn the engine switch off by pressing to the “OFF” position.

- For normal engine shutdown shut off all loads then unplug the electrical loads from generator panel receptacles. Never start or stop the engine with electrical devices plugged in and turned on.

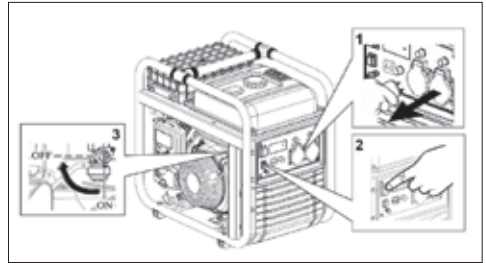

- Let engine run at no-load for several minutes to stabilise the internal temperatures of engine and generator.
- Move ON/OFF switch to OFF position.
- Close fuel valve.

Low Oil Level Shutdown System

The engine is equipped with a low oil level sensor that shuts down the engine automatically when the oil level drops below a specified level.

- If the engine shuts down by itself and the fuel tank has enough gasoline, check engine oil level. See page 11 for more info.

Maintenance

Generator Maintenance

Generator maintenance consists of keeping the unit clean and dry. Operate and store the unit in a clean dry environment where it will not be exposed to excessive dust, dirt, moisture or any corrosive vapours. Cooling air slots in the generator must not become clogged with debris.

- Check for any foreign materials while changing the engine oil and report to repair agent if necessary
- Check the cleanliness of the generator frequently and clean when dust, dirt, oil, moisture or other foreign substances are visible on its exterior surface.



CAUTION! *Never insert any object or tool through the air cooling slots, even if the engine is not running.*

Maintenance Schedule

Follow the calendar intervals shown below. More frequent service is required when operating in adverse conditions.

SERVICE	MAINTENANCE SCHEDULE
Engine Oil	Check the level before each use. First oil change after 20 hours of break-in. Subsequent oil changes every 100 hours of use.
Air Filter	Check and clean every 50 hours. Replace after 250 hour or before any damage is noticed.
Spark Plug	Check and adjust the electrode every 50 hours. Replace after 250 hours or before any damage is noticed.
Fuel Filter	Clean every 300 hours or 12 months (whichever is first)
Spark Arrester	Clean every 300 hours or 12 months (whichever is first)
Engine Valves	Adjust every 500 hours
Combustion Chamber	Clean every 500 hours*
Fuel Tank *	Clean every 500 hours*
Fuel Hose*	Replace every 2 years or sooner of any wear is noticed*

* Items should be maintained and repaired by an Authorized Powertec Service Supplier.

To Clean the Generator

- Use a damp cloth to wipe exterior surfaces.
- A soft, bristle brush may be used to remove dirt, oil etc.
- A vacuum cleaner may be used to pick up loose dirt and debris.
- Low pressure air (not to exceed 25psi) may be used to blow away dirt. Check cooling air slots and openings on the generator. These openings must be kept clean and unobstructed.



NOTE: *DO NOT use a garden hose to clean generator. Water can enter the engine fuel system and cause problems. In addition, if water enters the generator through cooling air slots, some water will be retained in voids and crevices of the rotor and stator winding insulation. Water and dirt build-up on the generator internal windings will eventually decrease the insulation resistance of these windings.*

NOTE: Perform maintenance more frequently when the generator is used in places with a lot of dust, high temperature or heavy load.

While maintaining the generator you should follow the service interval guide above, using the time interval which comes first.

If you have missed the scheduled time on the previous page to maintain your engine, do it as soon as possible.

NOTE: Lack of compliance with maintenance services will shorten the life of the generator and may produce malfunctions which are not covered by warranty.

General Recommendations

The warranty of the generator does not cover items that have been subjected to operator abuse or negligence. To receive full value from the warranty, the operator must maintain the generator as instructed in this manual.

Some adjustments will need to be made periodically to properly maintain the generator.

WARNING! Stop the engine before servicing. Place engine on a level surface and remove spark plug cap to prevent engine from starting.

Do not operate engine in a poorly ventilated room or other enclosed area. Be sure to keep good ventilation in working area. The exhaust from engine may contain poisonous CO, inhalation can cause shock, unconsciousness and even death.

Changing the Oil

- Keep the engine running for 5 to 10 minutes so the oil is heated, making it easier to drain completely.
- Turn off generator.
- Place an appropriate container under the oil draining hole to collect the used oil.
- Unscrew the oil drain screw by turning anti-clockwise.
- Release the oil plug.
- Turn the engine by gently pulling the recoil start which will dislodge oil from the moving parts of the engine.

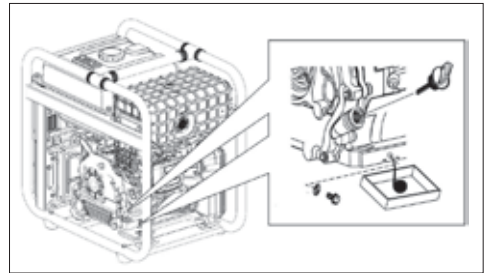

- Drain oil into container.
- Once oil has drained, place the drain screw and joint back and tighten
- Clean any spilt oil.
- Refill with recommended oil to the maximum level on the dipstick. See page 11 for more information.

RECOMMENDED OIL: SAE10W30

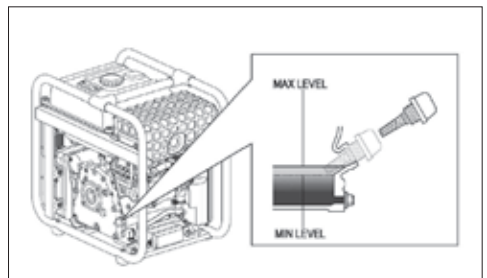

Air Filter Maintenance

NOTE: A dirty air filter will restrict the air flow in the carburetor, which may cause incorrect combustion, resulting in serious problems for the engine. Clean the air filter regularly according to the maintenance plan in this manual and more frequently in dusty areas.

NOTE: Never start the generator without the air filter as it may cause permanent damage.

NOTE: DO NOT use low flash point fuel or solvents when cleaning the air filter. They are flammable and explosive under certain conditions.

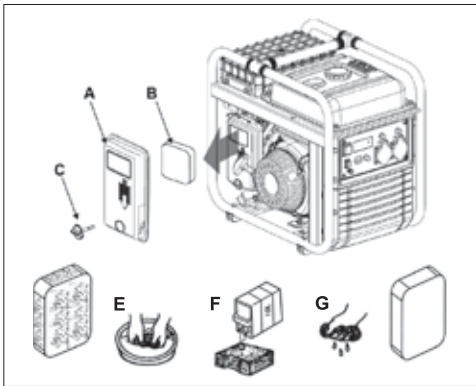

- Loosen and remove the air filter cover-screw (C).
- Take out the filter element (B).
- Clean the filter in a soap and water solution (E). Allow it to dry completely.
- Dip the dry filter in oil (F), the same type as used in the generator engine.
- Squeeze out excess oil (G). Generator will produce smoke from exhaust if not wrung out properly)
- Install filter element in the filter box, close cover and screw down.

Spark Plug Maintenance

RECOMMENDED SPARK PLUG: TORCH F6RTC, NGK BP7ES, BOSCH WR3C

- Unplug the spark plug cap by pulling outward (B).
- Using a spark plug spanner extract the sparkplug by unscrewing from the engine anti-clockwise (A).

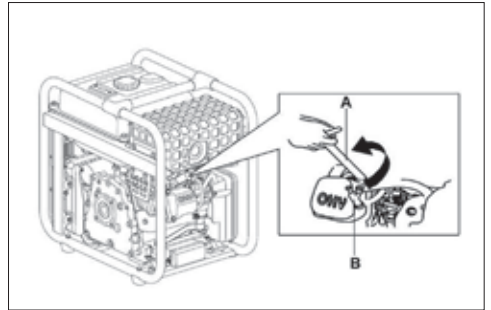

- Inspect the spark plug visually. Replace with a new one if cracked or chipped. Clean electrode with a fine wire brush.
- Measure electrode distance with a gauge and, if necessary, adjusted to specification.

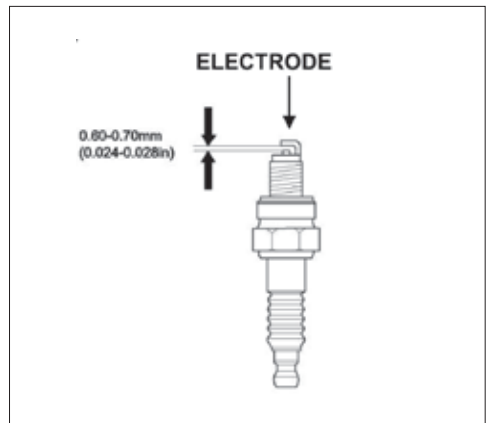

- Install spark plug with hands and then with spanner for final tightening, replace spark plug cap and screws.

⚠ NOTE: *The spark plug must be tightened firmly. A loose spark plug may overheat and even damage the engine. Similarly an over-tightened spark plug may damage the spark plug and the engine cylinder head thread.*

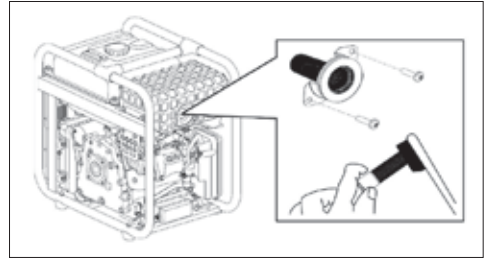

Fuel Filter Maintenance

⚠ WARNING! *Gasoline is flammable and explosive. DO NOT perform this maintenance while smoking or near an open flame.*

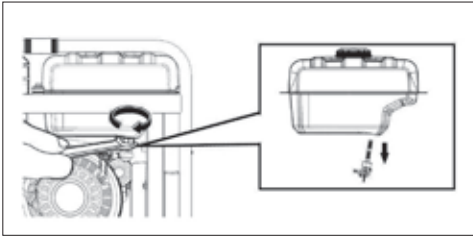

- Check fuel tank is empty. See page 11 for emptying fuel tank.
- Using a spanner, unscrew fuel valve, turning anti-clockwise.
- Remove fuel valve and check filter.
- Clean all residue from filter. Replace filter if necessary.
- Re-assemble.

Spark Arrester Maintenance

- Allow generator to cool completely.
- Remove the fixing screws.
- Clean carbon deposits carefully with a brush.
- Re-install the spark arrester.

Transportation & Storage

Transportation

In order to avoid fuel spillage during transportation, always keep the fuel valve in the “OFF” position. Fasten the machine so it can't move. Empty fuel from the generator if transporting on a bumpy road or cross country.

⚠ NOTE: *Never place the machine on its side or facing down during transportation. Keep upright at all times.*

⚠ WARNING! *DO NOT use the generator whilst transporting.*

⚠ DANGER! *DO NOT leave generator in a parked vehicle in the sun. An excessive rise in temperature could evaporate the fuel and cause an explosion.*

Storage

Fuel loses its properties when stagnant, from sitting for too long. Residues can clog up the carburetor, preventing start-up. If the generator is not going to be used for a period of time (2 to 3 months or more) it is important to drain the fuel from the tank, to avoid future starting problems.

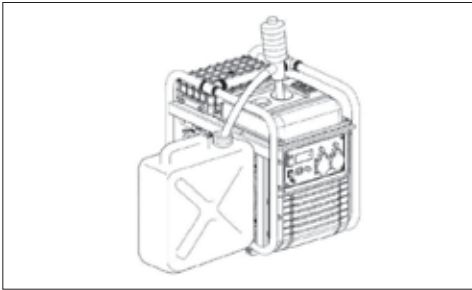

⚠ DANGER! *Drain fuel into approved container outdoors, away from open flame. Be sure engine is cool.*

- Remove the spark plug (see page 19 for more info on removing spark plug)
- Pour 1 tablespoon of clean motor oil (10-20ml) in the cylinder. Pull recoil handle gently, this will make the engine spin and distribute the oil.
- Install the spark plug.

⚠ NOTE: *DO NOT use regular plastic bottles for storing fuel as some plastics can partially decompose and fuel can be contaminated. Using contaminated fuel can cause damage to the engine.*

⚠ DANGER! *Fuel is flammable and explosive. Never smoke or generate any type of flame or flash while handling fuel.*

- Using a manual suction pump, extract fuel from the fuel tank and store in appropriate container.
- Place an appropriate container under the oil drain hole to collect the drained oil. (See page 11 for more info on draining oil.)
- Using a screwdriver, loosen the carburetor draining screw (A). Fuel will begin streaming from the carburetor draining hole (B). Once all of the fuel is drained, tighten the screw again.

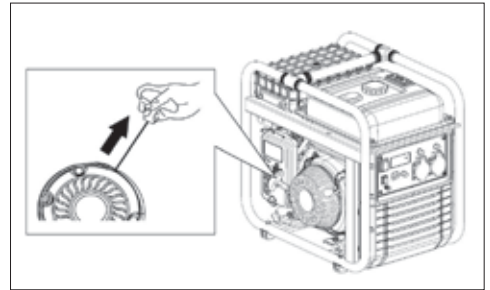

- Pull the recoil start slowly until you feel resistance. This closes the intake and exhaust valves, protecting against internal corrosion.

⚠ DANGER! *NEVER store engine with fuel in tank indoors or in enclosed, poorly ventilated areas where fumes may reach an open flame, spark or pilot light as on a furnace, water heater, clothes dryer or other gas appliance.*

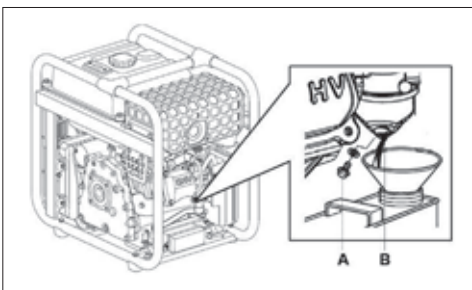

Other Storage Tips

- Do not store fuel from one season to another.
- Replace the fuel container if it starts to rust. Rust and/or dirt in the fuel will cause problems with the carburetor and fuel system.

- If possible, store the unit indoors and cover it to give protection from dust and dirt. **BE SURE TO EMPTY THE FUEL TANK.**
- If it is not practical to empty the fuel tank and the unit is to be stored for some time, use a commercially available fuel stabiliser added to the fuel to increase its life.

- Cover the unit with a suitable protective cover that does not retain moisture.



DANGER! NEVER cover the generator while engine and exhaust area are warm.

Troubleshooting

Trouble	Possible Cause	Suggested Remedy
Engine will not start or will not keep running	1. Low on fuel	1. Add fuel / oil mix
	2. Low on oil	2. Check oil level and top up
	3. Faulty spark plug	3. Replace spark plug
	4. Choke in wrong position	4. Adjust choke accordingly
	5. Fuel tap in closed position	5. Open fuel tap
	6. Unit loaded during start-up	6. Remove load from unit
	7. Spark plug wire loose	7. Attach wire to spark plug
	8. Dirty fuel filters	8. Clean filters as per instructions
No electrical output	1. Faulty receptacle	1. Have service centre replace receptacle
	2. Circuit breaker kicked out	2. Depress and reset
	3. Defective inverter unit	3. Have service centre replace inverter unit
	4. Faulty power cord	4. Replace cord
Repeated circuit breaker tripping	1. Overload	1. Reduce load
	2. Faulty cords or equipment	2. Check for damaged, bare or frayed wires on equipment. Replace.
	3. Circuit breaker is faulty	3. Have service centre replace circuit breaker
Generator overheating	1. Generator overloaded	1. Reduce load
	2. Insufficient ventilation	2. Move to adequate supply of fresh air



WARNING! Before attempting to service or troubleshoot the generator, the owner or service technician must first read and understand this instruction manual and comply with all safety instructions. Failure to follow all instructions may result in conditions leading to voiding of the product warranty, serious personal injury, property damage or even death.

Warranty

As part of an on-going commitment to excellence in product support, Euroquip offers a comprehensive product warranty program.

1. THIS WARRANTY:

The benefits provided to the consumer in this warranty are in addition to other rights and remedies of a consumer under the New Zealand Consumer Guarantees Act 1993 and any other laws in relation to the products to which this warranty relates. This warranty:

- Covers the product against faulty materials or workmanship; and
- Covers the replacement of parts, the repair labour used, a refund of the price of the product or replacement of the machine, or other compensation for the remainder of the warranty period.

This product warranty is only applicable to the original purchaser of the machine and only purchases made from Euroquip Authorized Retailers.

2) WARRANTY PERIODS:

Commercial Warranty*: 2 Years (24 months)
Domestic Warranty* : 4 Years (48 months)

Domestic Warranty applies to domestic use of the product: Personal, residential, or household use only. Commercial Warranty applies to commercial or business use of the product: All uses other than domestic use, including use for income-producing (including farming) or rental purposes.

*These GT Power Warranty periods are for products that are:

- Purchased from a New Zealand GT Power Dealer after 01/06/23
- Serviced by a GT Power Dealer in accordance with the GT Power service schedule, using genuine parts and the correct grade of oil (proof required)
- Meeting all other warranty requirements

NOTE: These warranty conditions apply to New Zealand only.

Euroquip warrants each new GT Power machine free from defect in material and workmanship under normal use and routine servicing, for the warranty periods specified. Conditional to the limitations and exclusions list below. The warranty period begins when the product is purchased by the end user. Warranty is not transferrable and is only claimable by the original purchaser.

Proof of purchase documentation with product serial number must be provided. If it has been lost and Euroquip does not have a record of the purchaser's details, the warranty period shall be calculated from the appropriate dealer wholesale sale date.

The purchaser must keep a record of all service and maintenance history as proof of servicing history. This may be requested when assessing any future warranty claims. The decision that an issue with a product qualifies as a warranty claim is made at the sole jurisdiction of Euroquip.

No costs incurred will be considered under warranty if repairs or maintenance are carried out by any party other than a Euroquip Approved Service Agent, unless with prior consent in writing from Euroquip.

It is the full responsibility of the purchaser to deliver the product under warranty to the nearest relevant service agent or product reseller. Warranty does not cover transportation costs including call outs, mileage and freight costs.

Customers are responsible for the care and cleaning of their product prior to sending it to our service centre. Any product being sent us must be thoroughly cleaned. Depending on what the product has come into contact with, it could pose an Occupational/ Work Health and Safety risk for our staff and or/service agents to inspect, repair or service a product that has come into contact with a hazardous substance. If we are asked to inspect, repair or service a product that has come into contact with a hazardous substance such as chemicals, asbestos or silica dust, we may not be able to inspect, service or repair the product. If this is the case, we will inform the purchaser and the product will be returned.

If a product is repaired under warranty, parts and labour required for the repair will be supplied at no charge. All defective parts replaced under warranty become property of Euroquip. Consumable items such as, but not limited to, oils, coolants, filter and spark plugs shall be the responsibility of the owner. Warranty assessment and repair will be scheduled and executed according to the normal work flow at the service location and depending on the availability of suitable replacement parts.

This warranty policy is an additional benefit and does not supersede the legal rights of any customer, reseller or service agent.

Should any issue be found to be a combination of a warranty failure and a non-warranty issue such as incorrect charging techniques, the repair cost component to rectify and repair the non-warranty failure is the **customer's** full responsibility.

3) EXCLUSIONS:

- Warranty does not cover parts that are subject to wear and tear from usage and/or damage which results from neglect of periodic maintenance.
- Evidence must be provided that the product has been maintained and serviced suitably for a claim to be considered under warranty.
- Batteries supplied with your product are warranted against defect for 3 months and does not include lack of charge due to non-use. Consumable items such as, but not limited to, oils, coolants, filters, spark plugs and batteries shall be the responsibility of the purchaser.
- Failure caused by incorrect operation of the product as specified in the manual either intentionally or by error.
- Lack of proper care and maintenance of the product.
- Any damage which results from unavoidable natural disasters, fire, collision, theft, etc.
- Any normal wear or deterioration, such as that of sliding or rotating parts caused under normal operating conditions.
- Any damage that results from misuse or use beyond the imitations of the products intended purpose (such as overloading or use under abnormal conditions).
- External circumstances such as product deterioration or corrosion due to environmental conditions like heat, cold, salt spray, sand or due to the passage of time
- Normal phenomena such as noise, vibration or oil seepage which are considered by Euroquip as not affecting the quality, function or performance of the product.
- Any damage due to improper storage or transport.
- Consumable replacement items: Spark plugs, contact points, shear pins, fuel strainers, oil filter elements, air cleaner elements, brake shoes or pads, clutch components, fuses, motor brushes, gaskets, tube or hoses, belts, cutting blades, light bulbs, serviceable bearings. Petroleum and others fluids: Oil, grease, battery electrolyte, and radiator coolant. Other items specified by Euroquip.
- Periodical maintenance items such as cleaning, inspection and adjustments.
- Contaminated fuel
- Modifications or installations of other products to the product
- Damage that results from the use of non-genuine parts, lubricant or fluid not approved by Euroquip
- Any repair and/or adjustment to correct improper or poor quality work previously performed.
- Attempted repair/ service by a party other than an Approved Service Agent, or any repair undertaken prior to approval of warranty by Euroquip is not covered under warranty.
- Warranty does not cover pre delivery service and adjustment, or failure that may occur as a result of lack of/ incorrect pre delivery service and adjustment. Warranty does not cover any incidental, indirect or consequential loss, damage, personal injury, or expense that may result from any defect, failure, malfunction, or misuse of a product.
- Any product that is found to have come into contact with hazardous substances such as chemicals, asbestos or silica dust and NOT been industrially cleaned prior to servicing.

4) HOW TO CLAIM WARRANTY:

In the event you are faced with a manufacturing fault with your GT Power product, you can claim a repair or part replacement under warranty if the following conditions are fulfilled:

- The problem is related to production quality or specifications of the machine
- The machine is within the warranty period outlined in schedule
- The issue does not fall within the warranty exclusions listed

If the criteria above is met, and you would like to request a warranty, then please go online to <https://www.euroquip.co.nz/Service-Request-End-User> and log your warranty claim.



GT3800Ei / GT4800Ei ELECTRIC START GENERATOR



Congratulations on your new GT POWER product. We are proud to have you as our customer and will strive to provide you with the best service and reliability in the industry. This product is backed by our extensive warranty and world-wide service network. Please contact your local agent or submit a service case online for fast response at www.gtpower.co.nz